



Oxford Cambridge and RSA

H

Tuesday 11 June 2019 – Morning

GCSE (9–1) Mathematics

J560/06 Paper 6 (Higher Tier)

Time allowed: 1 hour 30 minutes



You may use:

- a scientific or graphical calculator
- geometrical instruments
- tracing paper



Please write clearly in black ink. **Do not write in the barcodes.**

Centre number

--	--	--	--	--

Candidate number

--	--	--	--

First name(s)

Last name

INSTRUCTIONS

- Use black ink. You may use an HB pencil for graphs and diagrams.
- Answer **all** the questions.
- Read each question carefully before you start to write your answer.
- Where appropriate, your answers should be supported with working. Marks may be given for a correct method even if the answer is incorrect.
- Write your answer to each question in the space provided. Additional paper may be used if required but you must clearly show your candidate number, centre number and question number(s).

INFORMATION

- The total mark for this paper is **100**.
- The marks for each question are shown in brackets [].
- Use the π button on your calculator or take π to be 3.142 unless the question says otherwise.
- This document consists of **24** pages.

2

Answer **all** the questions.

- 1 A grain of salt weighs 6.48×10^{-5} kg on average.
A packet contains 0.35 kg of salt.

(a) Use this information to calculate the number of grains of salt in the packet.

(a) [2]

(b) Explain why your answer to part (a) is unlikely to be the actual number of grains of salt in the packet.

.....
.....
..... [1]

3

2 Tom researches the weights of plant seeds.

- One poppy seed weighs 3×10^{-4} grams.
- 250 pumpkin seeds weigh 21 grams.
- One sesame seed weighs 3.64×10^{-6} kilograms.

Write the three types of seed in order according to the weight of one seed.

Write the lightest type of seed first.

You must show how you decide.

.....,, [4]
lightest

- 3 (a) This spinner has two grey sections, two white sections and one black section.

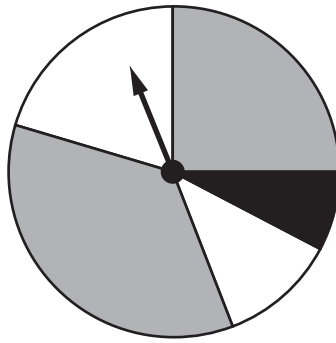

Vlad says

The probability of the spinner landing on black is $\frac{1}{5}$.

Explain why Vlad is not correct.

.....

.....

..... [1]

- (b) The graph shows the cost of a litre of petrol for the last six months of 2017.

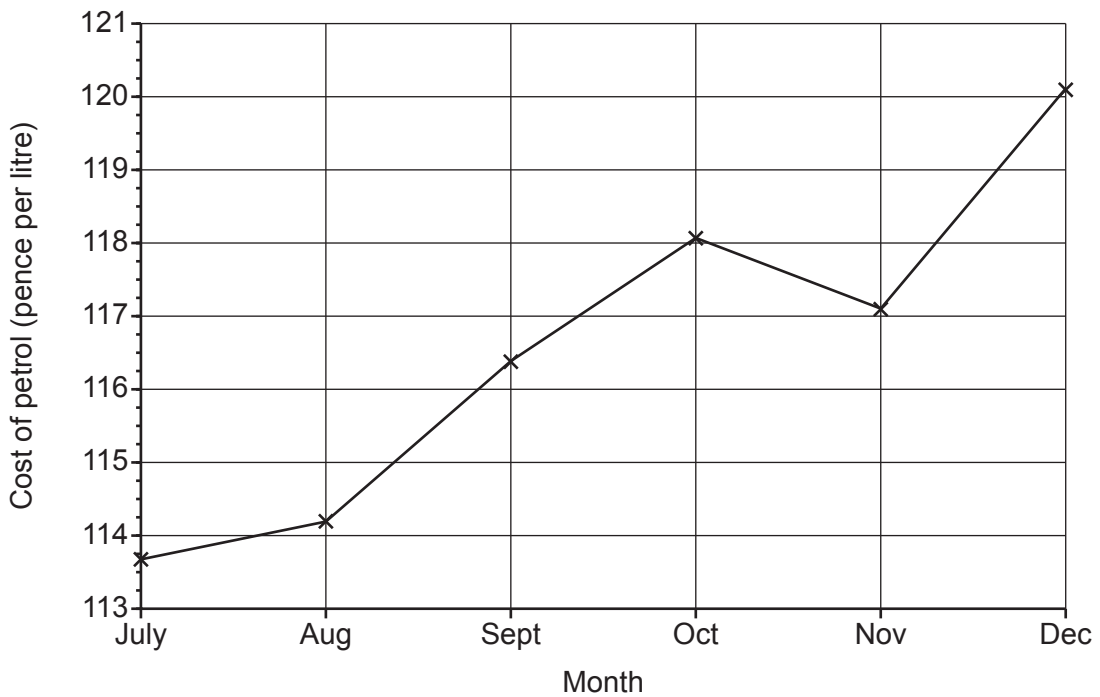

Explain why this graph is misleading.

.....

.....

..... [1]

4 Sophie is organising a raffle.

- Each raffle ticket costs 50p.
- She sells 400 tickets.
- The probability that a ticket, chosen at random, wins a prize is 0.1.
- Each winning ticket receives a prize worth £3.

Sophie says

I expect the raffle to make over £100 profit.

Show that Sophie is wrong.

.....
..... [4]

6

- 5 ABC is a right-angled triangle.
AB = 20 cm and BC = 37 cm.

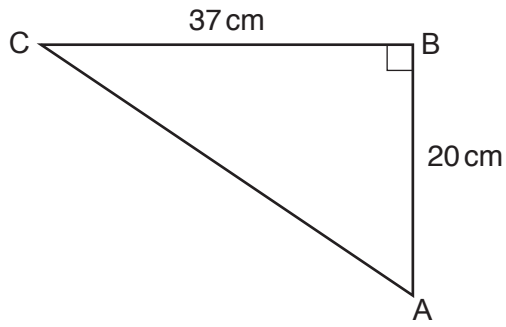

Not to scale

Calculate angle BAC.

..... ° [3]

6 A bag contains some counters.

- There are 300 counters in the bag.
- There are only red, white and blue counters in the bag.
- The probability of picking a blue counter is $\frac{23}{50}$.
- The ratio of red counters to white counters is 2 : 1.

Calculate the number of red counters in the bag.

..... [4]

8

- 7 Construct the perpendicular from the point P to the line AB.
Show all of your construction lines.

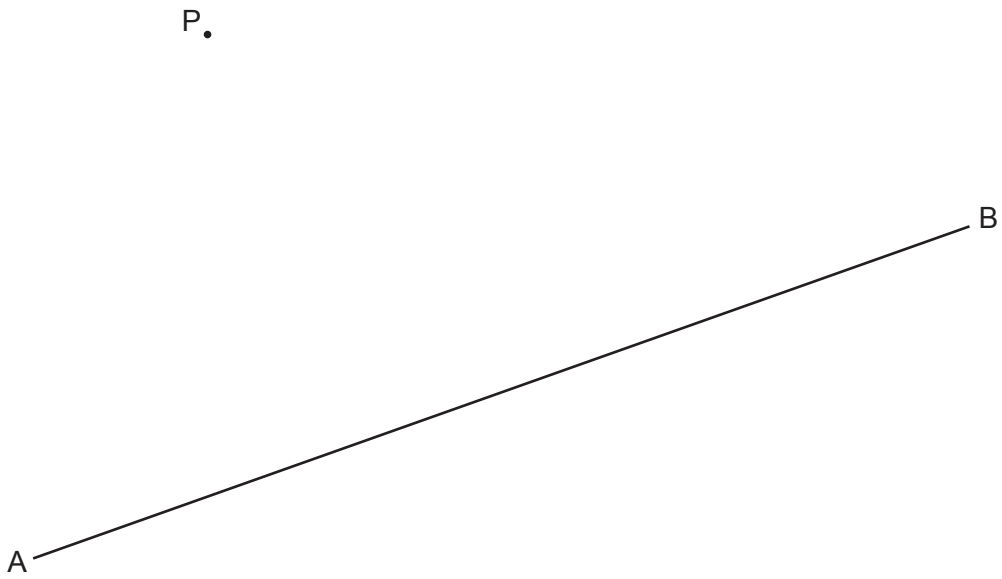

[2]

8 The graph shows two parallel lines, Line A and Line B.

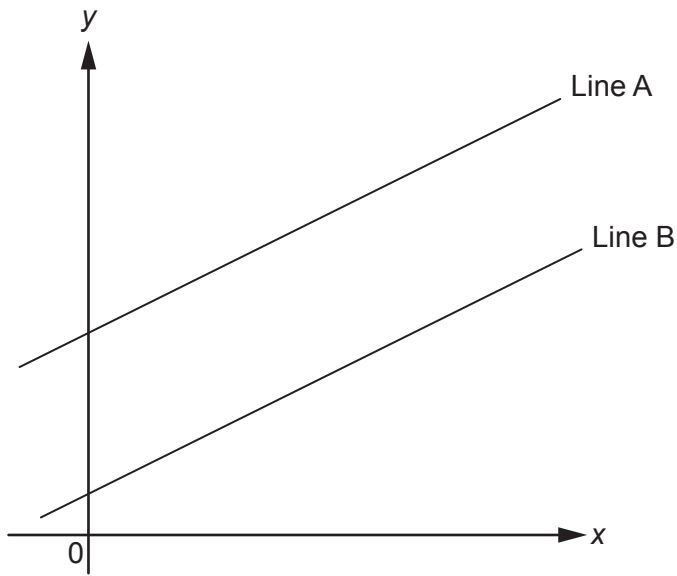

Not to scale

Line A has equation $y = 6x + 7$.
Line B passes through the point $(4, 26)$.

Find the equation of Line B.

..... [4]

10

- 9 Martha's solution to the inequality $8x + 5 \leq 3x - 10$ is shown on the number line.

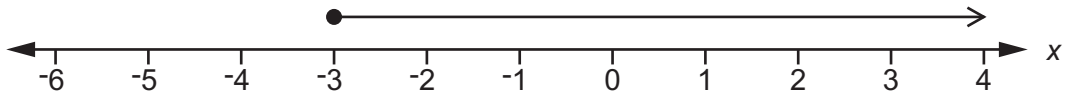

Is her solution correct?
Explain your reasoning.

.....
..... [4]

11

- 10 In 2017, the value of a house increased by 4%.
In 2018, the value of the house then decreased by 3%.

Teresa says

Over the two years the value of the house increased by exactly 1% because $4 - 3 = 1$.

Show that Teresa is wrong.

.....

..... [6]

11 You are given that

$$270 = 3^3 \times 2 \times 5 \quad \text{and} \quad 177\,147 = 3^{11}$$

- (a) (i) Find the lowest common multiple (LCM) of 270 and 177 147.
Give your answer using power notation and as an ordinary number.

(a)(i) using power notation
as an ordinary number [2]

- (ii) Write 177 147 000 000 as a product of its prime factors.

(ii) [3]

(b) $3^n = 177\,147 \times 9^5$.

Find the value of n .

(b) $n =$ [3]

12 Antonio rolls two fair six-sided dice and calculates the **difference** between the scores. For example, if the two scores are 2 and 5 or 5 and 2 then the difference is 3.

(a) Complete the sample space diagram to show the possible outcomes from Antonio's dice.

		Dice 2					
difference		1	2	3	4	5	6
Dice 1	1	0					
	2					3	
	3		1				
	4						
	5		3				
	6						

[2]

(b) Antonio rolls the two dice three times.

Calculate the probability that he gets a difference of 1 on all three rolls. Give your answer as a fraction in its lowest terms.

(b) [4]

13 Prove that the mean of any four **consecutive** even integers is an integer.

[4]

15

14 The length of the longest diagonal of a cube is 25 cm.

Calculate the total surface area of the cube.

..... cm² [5]

15 Solve by factorisation.

$$5x^2 + 7x + 2 = 0$$

$x = \dots\dots\dots$ or $x = \dots\dots\dots$ [3]

16 Sketch the graph of $y = -\sin x$ for $0^\circ \leq x \leq 360^\circ$.

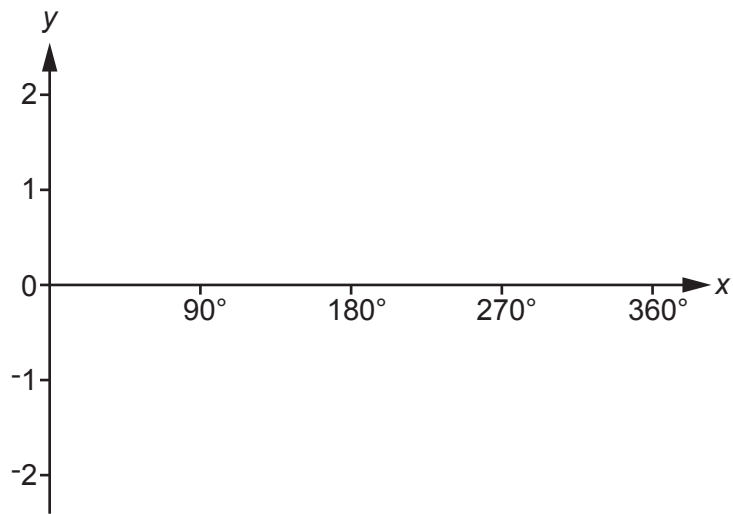

[3]

17 T is a radar tower.
A and B are two aircraft.

At 3pm

- aircraft A is 3250 km from T on a bearing of 015°
- aircraft B is 4960 km from T on a bearing of 057° .

Not to scale

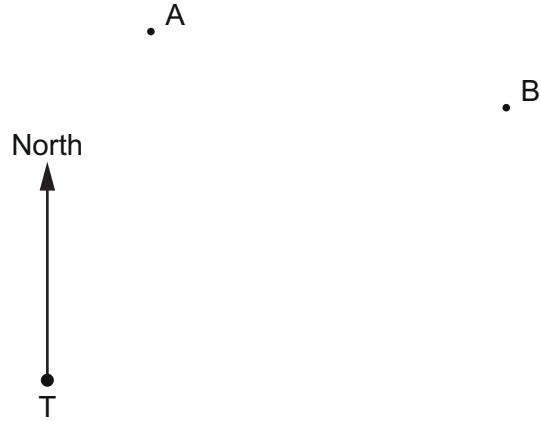

(a) Aircraft A flies directly towards radar tower T at a speed of 890 km/h.

At what time will the aircraft pass over radar tower T?
Give your answer to the nearest minute.

(a) [4]

(b) Calculate the distance that was between aircraft A and aircraft B at 3pm.

(b) km [4]

20

18 A cone has radius r cm and height h cm.

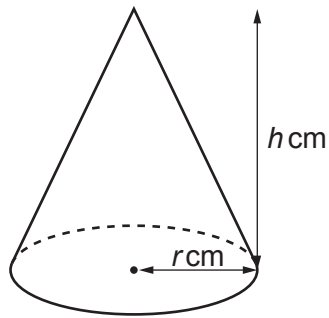

The height is three times the radius.
The volume of the cone is 2100 cm^3 .

Calculate the radius of the cone.

[The volume V of a cone with radius r and height h is $V = \frac{1}{3}\pi r^2 h$.]

..... cm [4]

19 The point $(-5, 2)$ lies on the circumference of a circle, centre $(0, 0)$.

(a) Find the equation of the circle.

(a) [4]

(b) Work out the gradient of the tangent to the circle at $(-5, 2)$.

(b) [2]

20 (a) Show that the equation $x^4 - x^2 - 9 = 0$ has a solution between $x = 1$ and $x = 2$. [3]

(b) Find this solution correct to 1 decimal place.
Show your working.

(b) $x = \dots\dots\dots$ [4]

23

- 21** Toy building bricks are available in two sizes, small and large.
The small and large bricks are mathematically similar.

A small brick has volume 8 cm^3 and width 2.1 cm .
A large brick has volume 15.625 cm^3 .

Calculate the width of a large brick.

..... cm **[4]**

Turn over for question 22

- 22 At the start of 2018, the population of a town was 17 150.
At the start of 2019, the population of the town was 16 807.

It is assumed that the population of the town is given by the formula

$$P = ar^t$$

where P is the population of the town t years after the start of 2018.

- (a) Write down the value of a .

(a) [1]

- (b) Show that $r = 0.98$.

[1]

- (c) Show that the population is predicted to be less than 16 000 at the start of 2022.

[2]

- (d) Use the formula to work out what the population might have been at the start of 2017.

(d) [2]

END OF QUESTION PAPER



Oxford Cambridge and RSA

Copyright Information

OCR is committed to seeking permission to reproduce all third-party content that it uses in its assessment materials. OCR has attempted to identify and contact all copyright holders whose work is used in this paper. To avoid the issue of disclosure of answer-related information to candidates, all copyright acknowledgements are reproduced in the OCR Copyright Acknowledgements Booklet. This is produced for each series of examinations and is freely available to download from our public website (www.ocr.org.uk) after the live examination series.

If OCR has unwittingly failed to correctly acknowledge or clear any third-party content in this assessment material, OCR will be happy to correct its mistake at the earliest possible opportunity.

For queries or further information please contact The OCR Copyright Team, The Triangle Building, Shaftesbury Road, Cambridge CB2 8EA.

OCR is part of the Cambridge Assessment Group; Cambridge Assessment is the brand name of University of Cambridge Local Examinations Syndicate (UCLES), which is itself a department of the University of Cambridge.